



IEC 309 HP: range of plugs and socket-outlets complying with the safety requisites defined by the international Standards IEC 60309-1 and IEC 60309-2 and assimilated at European level as EN 60309-1 and EN 60309-2. This range expands GEWISS's assortment from 16A to 125A straight plugs, straight connectors and 10° flush-mounting socket-outlets with IP44/IP54 and IP66/IP67/IP68/IP69 degrees of protection to ensure full protection for all applications. The technopolymers and thickness used for the parts made of insulating material guarantee an elevated degree of mechanical and chemical agent resistance. All the sleeves and pins of the IEC 309 HP socket-outlets and plugs are surface-treated with nickel-plating to ensure full protection against corrosion, oxidation and abrasion. All the external metallic elements of the IEC 309 HP plugs and socket-outlets are made of stainless steel (the threaded metallic inserts for the body-grip coupling of the 63-125A versions are made of brass).

Colour	Red	Rated current (A)	63
IP degree	IP66/IP67	No. of poles	3P+N+E
Mechanical resistance	IK09	Reference h	6
Flange dimensions (mm)	110x100	Type	10° angled flush-mounting socket-outlet
Rated voltage	346 - 415 V	Frequency	50/60 Hz
Terminal tightening capacity	6-16mm ² flexible cables - 6-25mm ² rigid cables	Operating temperature	-25 +55 °C
Type of wiring	Mantle terminal	Type of material	Halogen-free in compliance with EN 60754-2
Electrocod	2211	Glow wire test	850 °C (active parts) - 650 °C (passive parts)
Total number of operations	> 2000	Breaking capacity at 1.1 Un	79 A
Insulation resistance	> 10 MΩ	Thermo-pressure with ball	125 °C (active parts) - 80 °C (passive parts)

BEHAVIOUR WITH CHEMICAL AND ATMOSPHERIC AGENTS

Saline solution	Acids		Bases		Solvents				Mineral oil	UV rays
	Concentrated	Diluted	Concentrated	Diluted	Hexane	Benzol	Acetone	Alcohol		
Resistant	Not resistant	Limited resistance	Limited resistance	Resistant	Resistant	Resistant	Resistant	Resistente	Resistant	Resistant

DIMENSIONAL

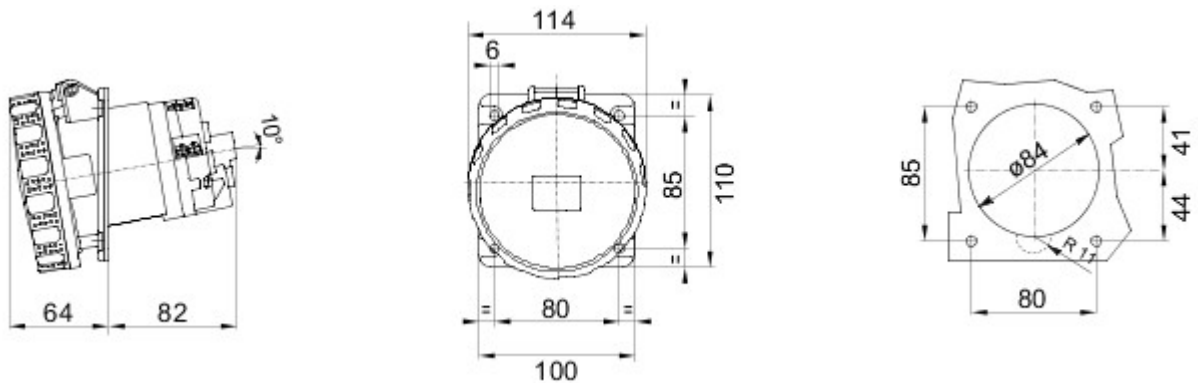

TECHNICAL SYMBOLOGY

IP IP66/IP67	IK IK09	INSTALLATION -25 °C min / +55 °C max -25 +55 °C	Mantle terminal	HF HALOGEN FREE Halogen-free in compliance with EN 60754-2	GWT 850 °C (active parts) - 650 °C (passive parts)	↓ 125 °C (active parts) - 80 °C (passive parts)
------------------------	-------------------	--	------------------------	---	--	---

STANDARDS/APPROVALS

